

BC-144
 $\frac{1\frac{1}{2}''}{1} \times \frac{1\frac{3}{4}''}{1}$

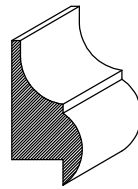

BC-143
 $\frac{1\frac{1}{16}''}{1} \times \frac{2\frac{1}{8}''}{1}$

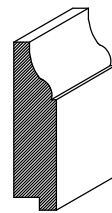

BC-115
 $\frac{8''}{8} \times \frac{2\frac{1}{2}''}{2}$

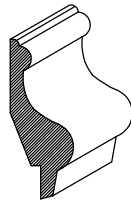

BC-069
 $\frac{3''}{2} \times \frac{2\frac{3}{8}''}{8}$

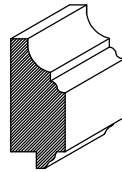

BC-123
 $\frac{1\frac{3}{16}''}{16} \times \frac{2''}{2}$

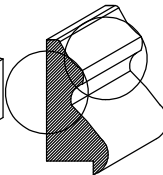

BC-089
 $\frac{8''}{8} \times \frac{2\frac{3}{8}''}{8}$



BC-311
 $\frac{3}{4}'' \times 2''$

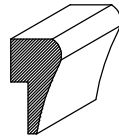

BC-252
 $\frac{3}{4}'' \times 1\frac{3}{8}''$

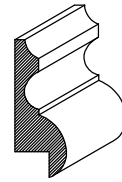

BC-439
 $\frac{3}{4}'' \times 2''$

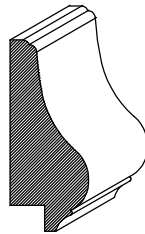

BC-284
 $1\frac{1}{8}'' \times 2\frac{1}{4}''$

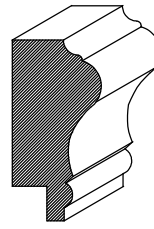

BC-346
 $1\frac{1}{4}'' \times 2\frac{3}{8}''$

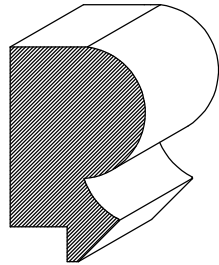

BC-457
 $\frac{1}{8}'' \times 2\frac{1}{2}''$

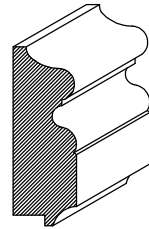

BC-475
 $\frac{3}{4}'' \times 2''$

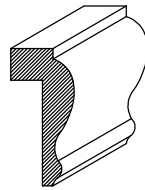

BC-522
 $\frac{3}{4}'' \times 1\frac{5}{8}''$

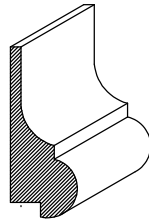

BC-489
 $\frac{3}{4}'' \times 2''$

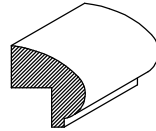

BC-486
 $\frac{7}{8}'' \times \frac{7}{8}''$

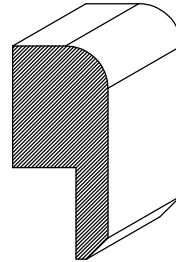

BC-180
 $\frac{1}{8}'' \times 2\frac{1}{2}''$

J - 4

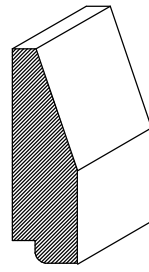

BC-701
 $\frac{3}{4}'' \times 2\frac{1}{2}''$

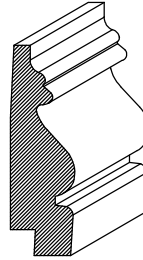

BC-728
 $\frac{3}{4}'' \times 2\frac{1}{2}''$

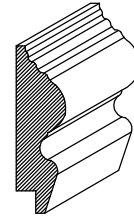

BC-649
 $\frac{1}{2}'' \times 2''$

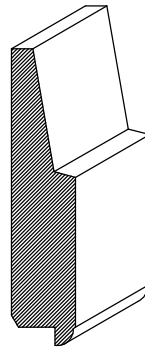

BV535
 $1\frac{3}{4}'' \times 3\frac{3}{8}''$

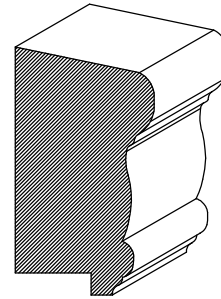

BC-691
 $1\frac{5}{8}'' \times 2\frac{7}{8}''$

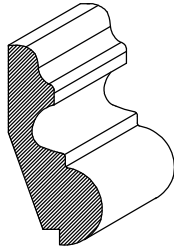

BC-700
 $\frac{3}{4}'' \times 2\frac{1}{2}''$

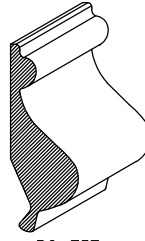

BC-737
 $\frac{7}{8}'' \times 2\frac{1}{4}''$

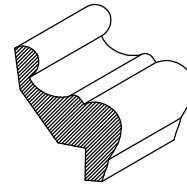

BC-752
 $\frac{3}{4}'' \times 1\frac{7}{8}''$

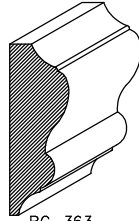

BC-363
 $\frac{11}{16}'' \times 2''$

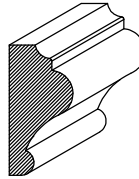

BC-573
 $\frac{3}{4}'' \times 1\frac{9}{16}''$

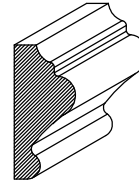

BC-735
 $\frac{3}{4}'' \times 1\frac{7}{8}''$

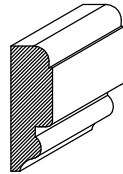

BC-675
 $\frac{1}{2}'' \times 1\frac{1}{2}''$

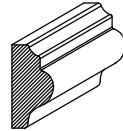

BC-149
 $\frac{1}{2}'' \times 1''$

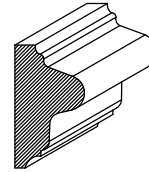

BC-342
 $\frac{7}{8}'' \times 1\frac{7}{16}''$

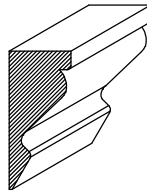

BC-009
 $\frac{11}{16}'' \times 1\frac{1}{2}''$

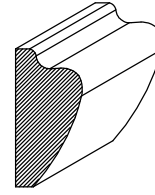

BC-762
 $\frac{3}{4}'' \times 1\frac{1}{2}''$

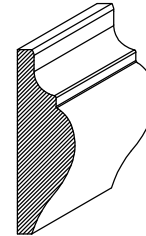

BC-292
 $\frac{5}{8}'' \times 2''$



BC-275
 $1\frac{3}{8}'' \times 3\frac{1}{4}''$

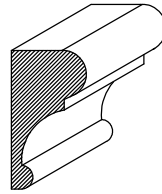

BC-487
 $\frac{1}{8}'' \times 1\frac{5}{8}''$

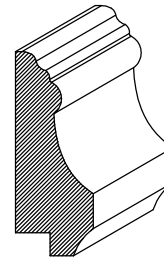

BC-769
 $\frac{13}{16}'' \times 2\frac{1}{4}''$

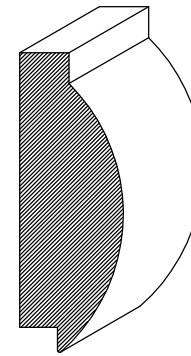

BC-819
 $1\frac{1}{8}'' \times 3\frac{1}{4}''$

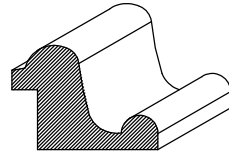

BC-454
 $\frac{1\frac{1}{8}''}{8} \times 1\frac{3}{4}''$

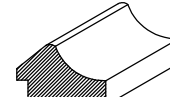

BC-862
 $\frac{3}{4}'' \times 1\frac{1}{16}''$

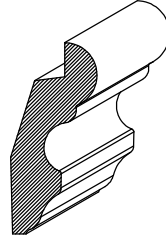

BC-865
 $\frac{3}{4}'' \times 2\frac{3}{8}''$

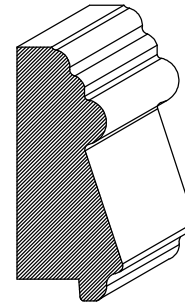

BC-833
 $\frac{1}{8}'' \times 3\frac{1}{8}''$

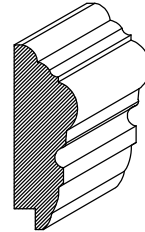

BC-842
 $\frac{3}{4}'' \times 2\frac{1}{4}''$

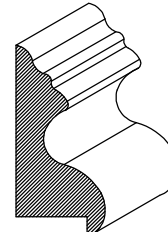

BC-878
 $\frac{1\frac{1}{16}''}{16} \times 2\frac{1}{4}''$

BC-275
 $\frac{1\frac{3}{8}''}{8} \times 3\frac{1}{4}''$

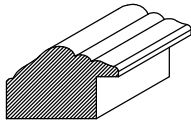

BC-890
 $\frac{7}{8}'' \times 1 \frac{5}{16}''$

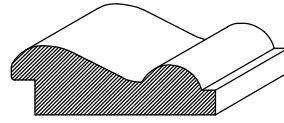

BC-941
 $\frac{1 \frac{5}{16}'' \times 2 \frac{1}{16}''$

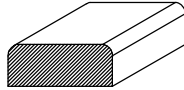

BC-966
 $\frac{1}{2}'' \times 1 \frac{1}{4}''$

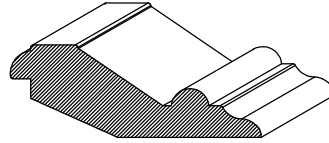

BC-908
 $1 \frac{1}{8}'' \times 3''$

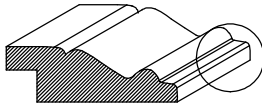

BC-953
 $\frac{1 \frac{1}{16}'' \times 2 \frac{1}{16}''$

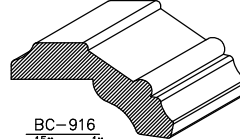

BC-916
 $\frac{1 \frac{5}{16}'' \times 1 \frac{1}{8}''$

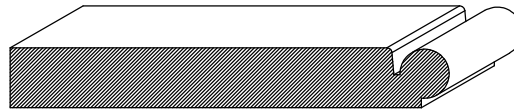

BC-929
 $\frac{1 \frac{1}{16}'' \times 5 \frac{1}{4}''$

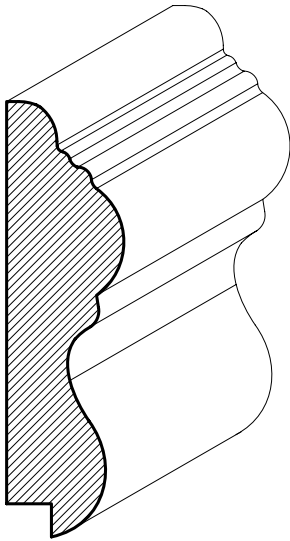

BC-1069
 $\frac{5}{8}'' \times 2 \frac{1}{4}''$

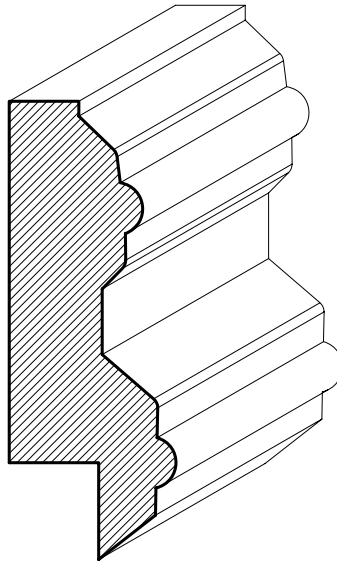

BC-11109
 $\frac{7}{8}'' \times 2 \frac{3}{8}''$