

BC-022
 $\frac{3}{4}'' \times 2\frac{1}{2}''$

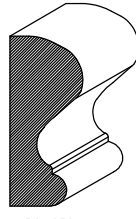

BC-052
 $1\frac{1}{8}'' \times 2\frac{1}{8}''$

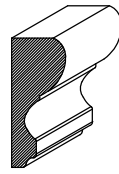

BC-147
 $1\frac{1}{8}'' \times 2''$

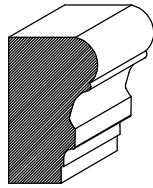

BC-100
 $1\frac{1}{8}'' \times 2\frac{1}{4}''$

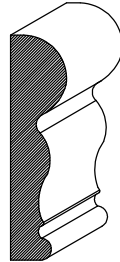

BC-215
 $\frac{7}{8}'' \times 3\frac{1}{2}''$

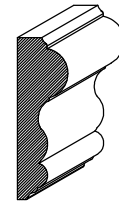

BC-202
 $\frac{3}{4}'' \times 2\frac{1}{4}''$

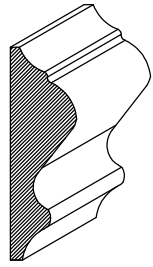

BC-072
 $\frac{1\frac{3}{8}}{16} \times 2\frac{1}{2}$ "

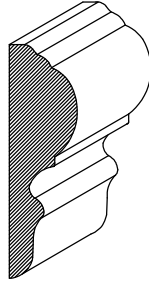

BC-507
 $\frac{1\frac{3}{8}}{16} \times 2\frac{1}{4}$ "

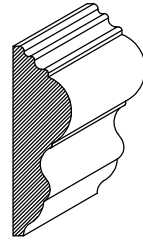

BC-263
 $\frac{3}{4} \times 2\frac{1}{4}$ "

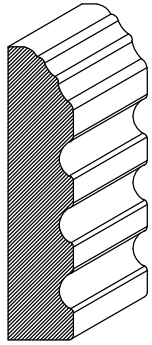

BC-188
 $\frac{3}{4} \times 3\frac{1}{2}$ "

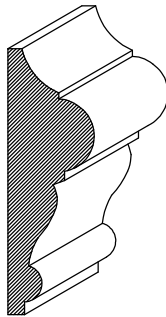

BC-290
 $1 \times 3\frac{1}{8}$ "

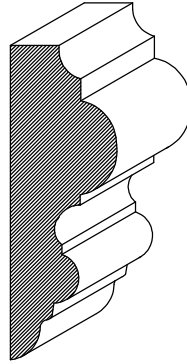

BC-316
 $\frac{1}{4} \times 3\frac{11}{16}$ "

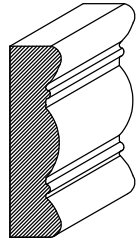

BC-219
 $\frac{5}{8}'' \times 2\frac{1}{4}''$

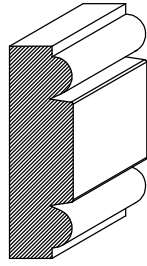

BC-229
 $\frac{3}{4}'' \times 2\frac{1}{2}''$

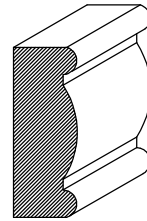

BC-387
 $\frac{3}{4}'' \times 2''$

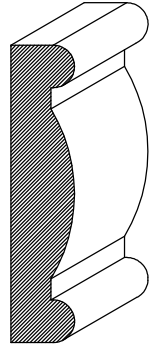

BC-388
 $\frac{3}{4}'' \times 3\frac{1}{2}''$

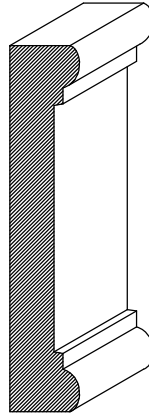

BC-444
 $\frac{13}{16}'' \times 4\frac{1}{4}''$

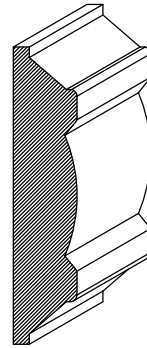

BC-523
 $\frac{3}{4}'' \times 3\frac{1}{2}''$

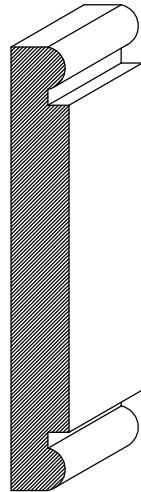

BC-377
 $\frac{11}{8}$ " x $5\frac{1}{4}$ "

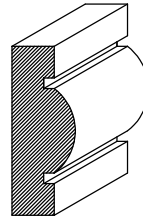

BC-544
 $\frac{3}{4}$ " x 2"

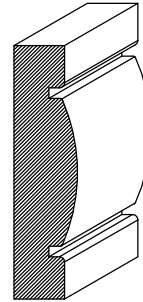

BC-533
 $\frac{3}{4}$ " x 3"

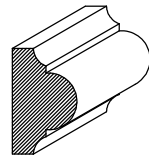

BC-259
 $\frac{3}{4}$ " x $1\frac{1}{4}$ "

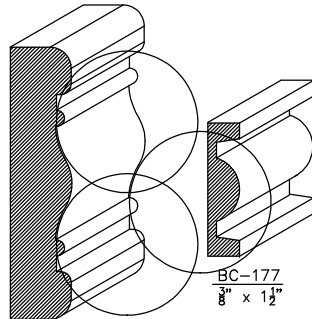

BC-177
 $\frac{5}{8}$ " x $1\frac{1}{2}$ "

BC-583
 $\frac{3}{4}$ " x $3\frac{1}{4}$ "

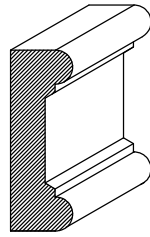

BC-258
 $\frac{11}{16}'' \times 2''$

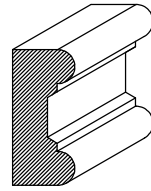

BC-257
 $\frac{11}{16}'' \times 1\frac{1}{2}''$

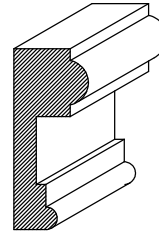

BC-414
 $\frac{3}{4}'' \times 2''$

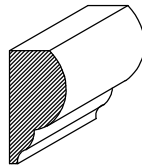

BC-019
 $\frac{3}{4}'' \times 1\frac{1}{4}''$

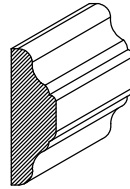

BC-148
 $\frac{1}{2}'' \times 1\frac{1}{2}''$

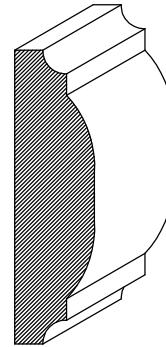

BC-006
 $\frac{7}{8}'' \times 3\frac{1}{4}''$

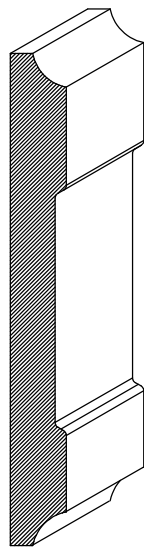

BC-520
 $\frac{5}{8}'' \times 5\frac{1}{2}''$

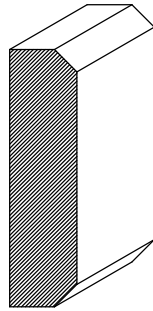

BC-004
 $\frac{3}{4}'' \times 2\frac{7}{8}''$

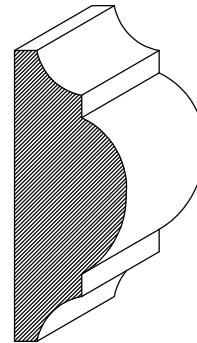

BC-090
 $1\frac{1}{4}'' \times 3\frac{1}{4}''$

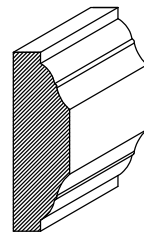

BC-161
 $\frac{5}{8}'' \times 2''$

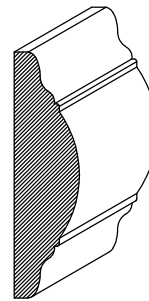

BC-243
 $\frac{3}{4}'' \times 2\frac{3}{4}''$

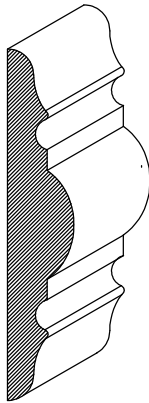

BC-509
 $\frac{3}{4}'' \times 4''$

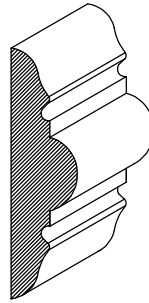

BC-389
 $\frac{3}{4}'' \times 2\frac{7}{8}''$

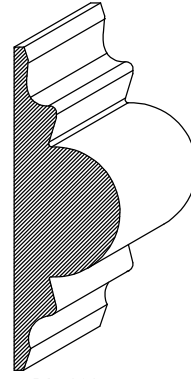

BC-696
 $1\frac{1}{4}'' \times 3\frac{5}{8}''$

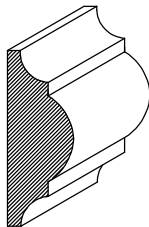

BC-459
 $\frac{5}{8}'' \times 2''$

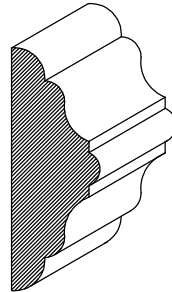

BC-524
 $1'' \times 2\frac{3}{4}''$

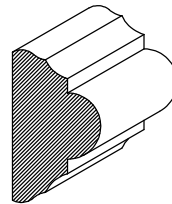

BC-526
 $1'' \times 1\frac{1}{4}''$

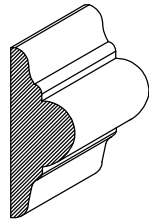

BC-635
 $\frac{3}{4}'' \times 2''$

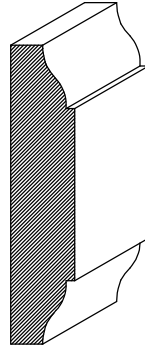

BC-415
 $\frac{3}{4}'' \times 3\frac{1}{2}''$

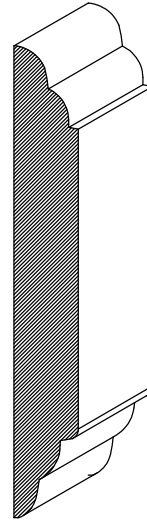

BC-645
 $\frac{3}{4}'' \times 5\frac{1}{2}''$

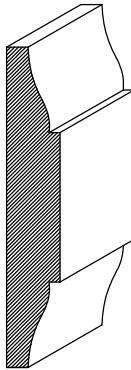

BC-565
 $\frac{5}{8}'' \times 3\frac{3}{4}''$

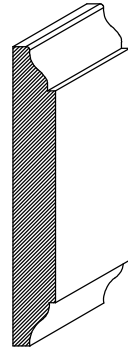

BC-637
 $\frac{1}{2}'' \times 3\frac{1}{2}''$

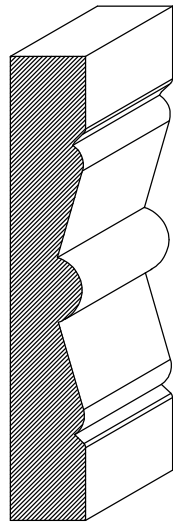

BC-277
 $\frac{3}{4}'' \times 4\frac{5}{8}''$

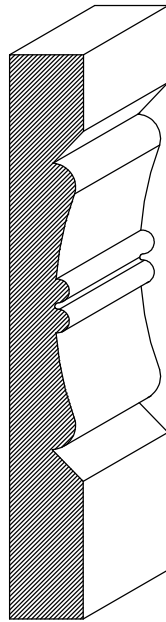

BC-481
 $\frac{3}{4}'' \times 5\frac{5}{8}''$

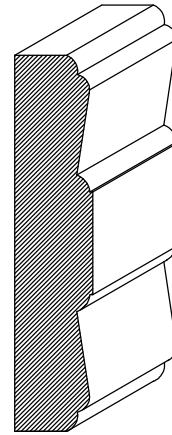

BC-552
 $\frac{3}{4}'' \times 3\frac{3}{4}''$

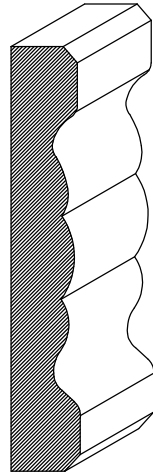

BC-746
 $\frac{13}{16}$ " x 5"

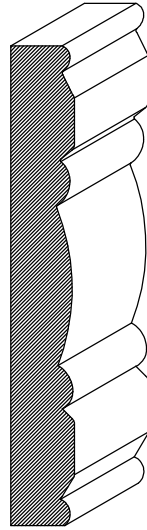

BC-713
 $\frac{3}{4}$ " x $5\frac{5}{8}$ "

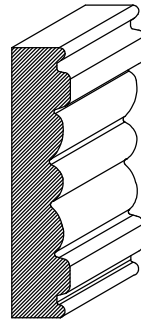

BC-673
 $\frac{11}{16}$ " x $3\frac{1}{4}$ "

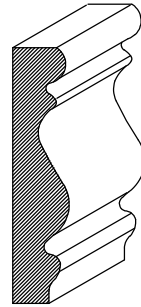

BC-733
 $\frac{11}{16}$ " x 3"

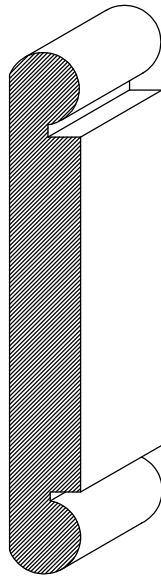

BC-648
 $\frac{3}{4}'' \times 5\frac{1}{2}''$

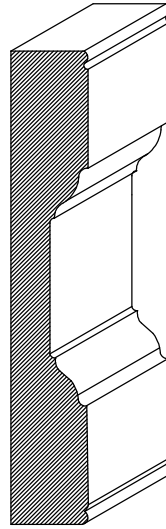

BC-743
 $\frac{1}{8}'' \times 5''$

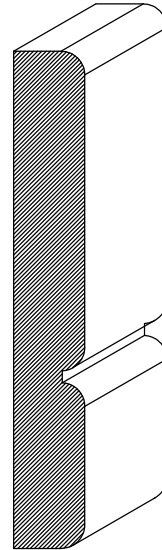

BC-580
 $\frac{3}{4}'' \times 5\frac{1}{4}''$

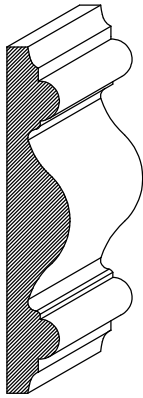

BC-553
 $\frac{3}{4}'' \times 4\frac{1}{8}''$

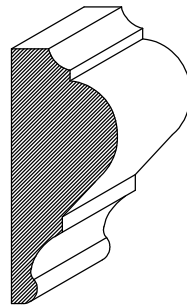

BC-364
 $1\frac{1}{4}'' \times 3''$

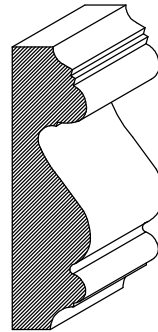

BC-646
 $\frac{1}{8}'' \times 3''$

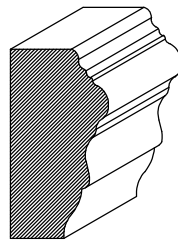

BC-732
 $1\frac{1}{8}'' \times 2\frac{1}{4}''$

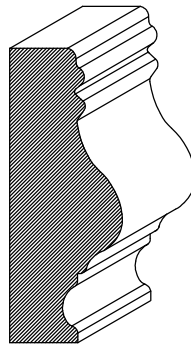

BC-749
 $1\frac{3}{8}'' \times 3\frac{1}{2}''$

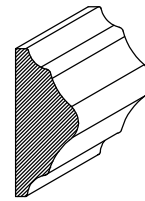

BC-604
 $\frac{3}{4}'' \times 1\frac{3}{4}''$

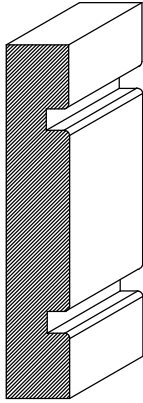

BC-657
 $\frac{3}{4}'' \times 4\frac{1}{8}''$

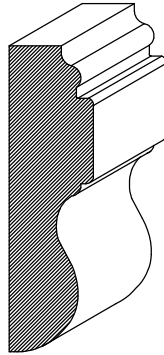

BC-686
 $1'' \times 3\frac{7}{8}''$

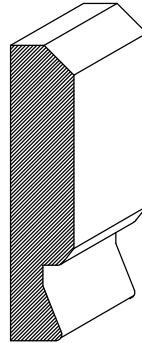

BC-719
 $\frac{3}{4}'' \times 3\frac{1}{2}''$

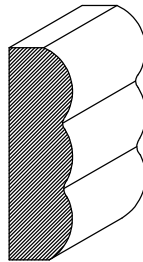

BC-680
 $\frac{3}{4}'' \times 2\frac{1}{2}''$

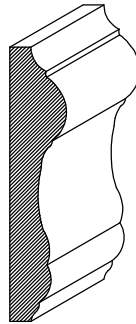

BC-146
 $\frac{5}{8}'' \times 3\frac{1}{4}''$

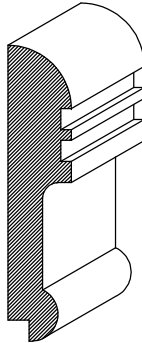

BC-354
 $\frac{3}{4}'' \times 3\frac{1}{2}''$

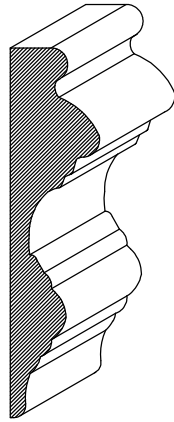

BC-087
 $1'' \times 4\frac{1}{4}''$

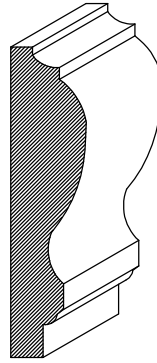

BC-198
 $\frac{7}{8}'' \times 3\frac{5}{8}''$

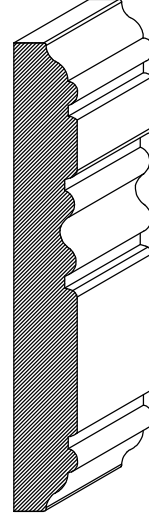

BC-217
 $\frac{3}{4}'' \times 5\frac{1}{2}''$

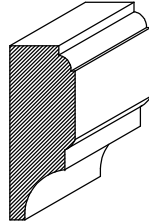

BC-446
 $\frac{3}{4}'' \times 2''$

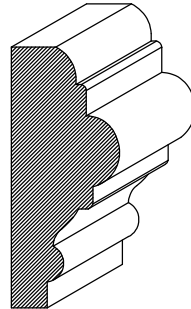

BC-291
 $1\frac{1}{4}'' \times 3''$

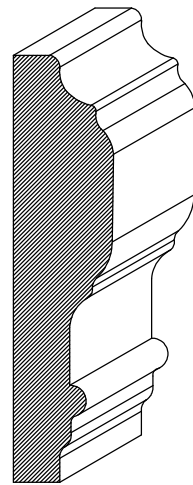

BC-777
 $1\frac{1}{16}'' \times 4\frac{1}{2}''$

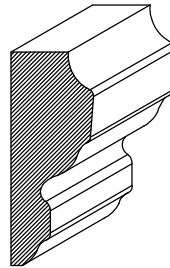

BC-826
 $\frac{7}{8}'' \times 2\frac{1}{4}''$

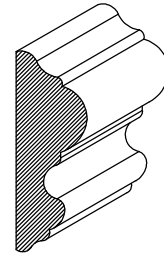

BC-785
 $\frac{3}{4}'' \times 2\frac{1}{8}''$

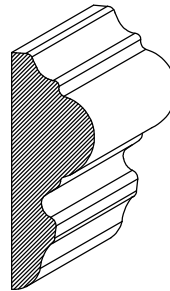

BC-870
 $\frac{7}{8}'' \times 2\frac{1}{2}''$

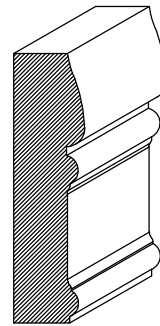

BC-766
 $\frac{3}{4}'' \times 2\frac{1}{8}''$

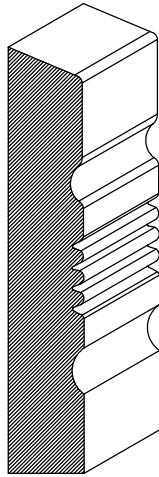

BC-184
 $\frac{7}{8}'' \times 4\frac{7}{8}''$

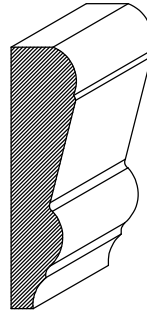

BC-863
 $\frac{3}{4}'' \times 3''$

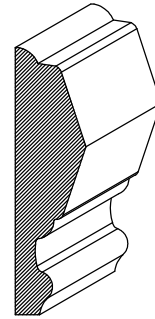

BC-879
 $\frac{13}{16}'' \times 3''$

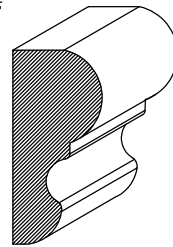

BC-924
 $1'' \times 2\frac{1}{4}''$

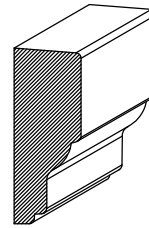

BC-917
 $\frac{3}{4}'' \times 2''$

D - 17

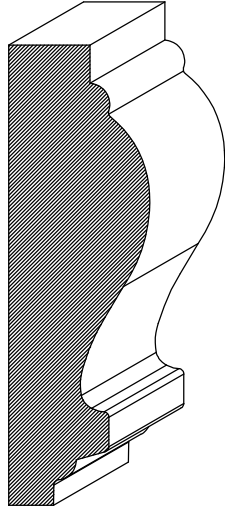

BC-977
 $1 \frac{5}{8}'' \times 5 \frac{3}{16}''$

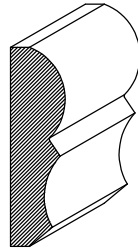

BC-970
 $\frac{5}{8}'' \times 2 \frac{1}{16}''$

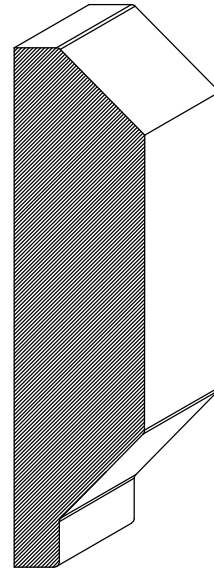

BC-895
 $1 \frac{1}{2}'' \times 6''$

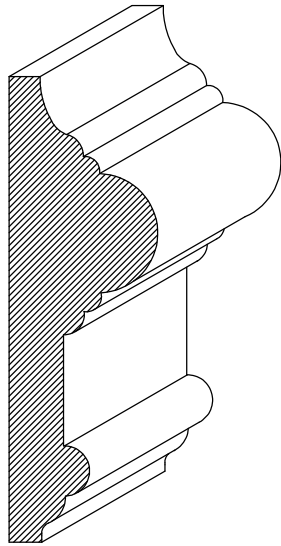

BC-986
 $1 \frac{1}{16}'' \times 3 \frac{1}{4}''$

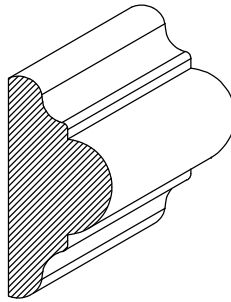

BC-896
 $\frac{3}{4}'' \times 1 \frac{9}{16}''$

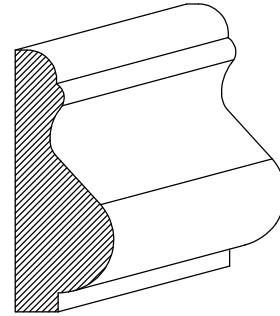

BC-1013
 $\frac{11}{16}'' \times 1 \frac{13}{16}''$

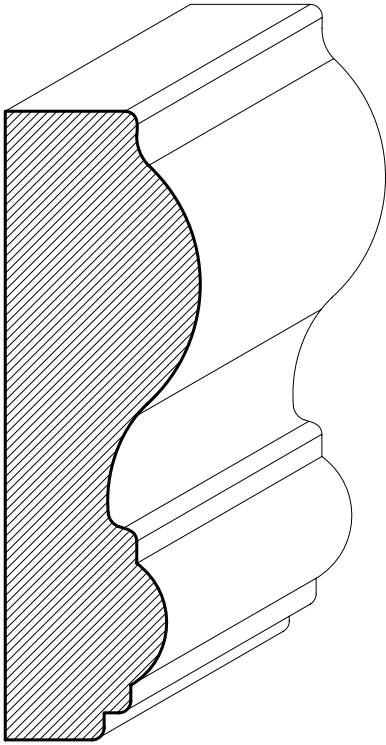

BC-1030
 $1" \times 3 \frac{1}{4}"$

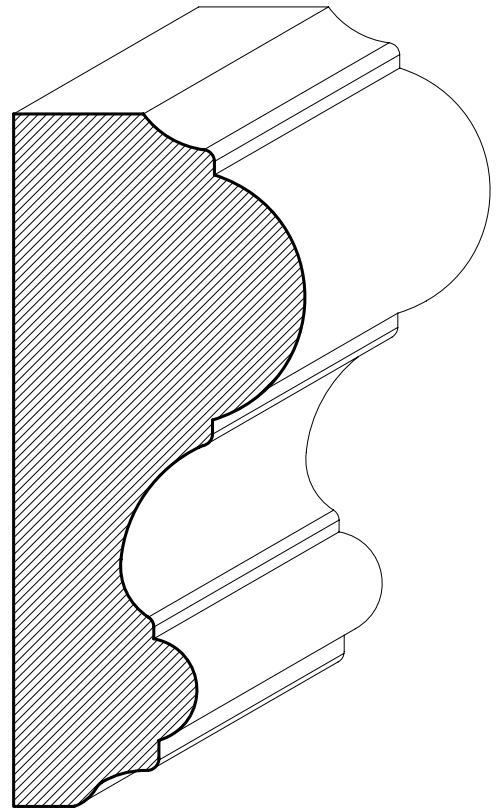

BC-1018
 $1 \frac{1}{2}" \times 3 \frac{9}{16}"$

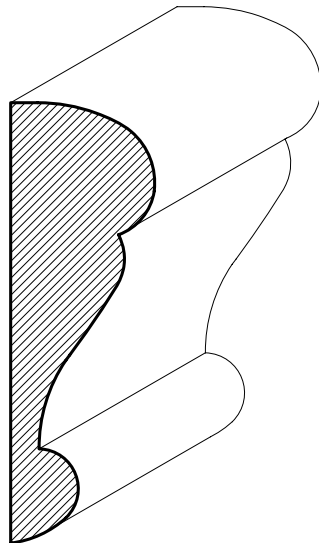

BC-1033
 $\frac{3}{4}" \times 2 \frac{1}{4}"$

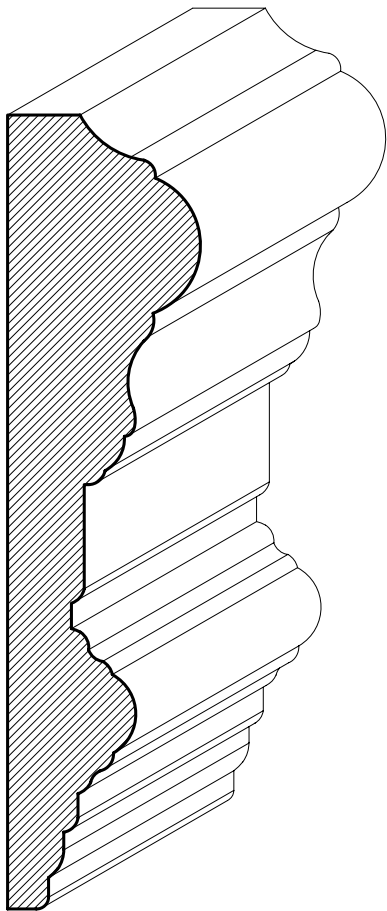

BC-1061
1" X 4 $\frac{1}{8}$ "