

BC-045
 $\frac{1\frac{1}{8}''}{16} \times 1\frac{1}{8}''$

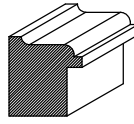

BC-330
 $\frac{1\frac{1}{8}''}{16} \times 1\frac{1}{4}''$

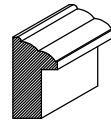

BC-169
 $\frac{5}{8}'' \times 1\frac{1}{4}''$

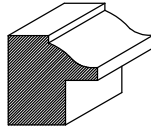

BC-206
 $\frac{1\frac{1}{4}''}{2} \times 1\frac{1}{8}''$

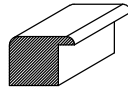

BC-251
 $\frac{3}{4}'' \times 1''$

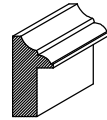

BC-197
 $\frac{5}{8}'' \times 1\frac{1}{4}''$

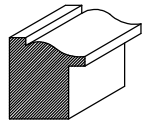

BC-246
 $\frac{1\frac{1}{4}''}{2} \times 1\frac{1}{8}''$

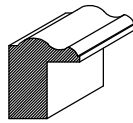

BC-318
 $\frac{1\frac{1}{8}''}{16} \times 1\frac{1}{4}''$

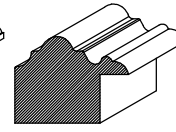

BC-321
 $\frac{1\frac{1}{4}''}{2} \times 1\frac{1}{8}''$

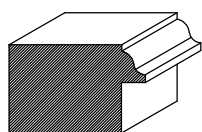

BC-623
 $\frac{1\frac{1}{2}}{8}'' \times 2\frac{1}{8}''$

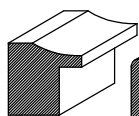

BC-397
 $\frac{1\frac{1}{4}}{8}'' \times 1\frac{1}{8}''$

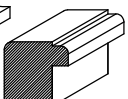

BC-106
 $1'' \times 1''$

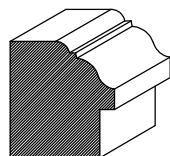

BC-441
 $\frac{1}{8}'' \times 1\frac{1}{8}''$

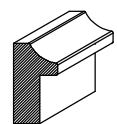

BC-442
 $\frac{1}{8}'' \times 1\frac{1}{4}''$

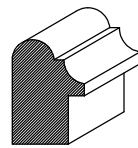

BC-578
 $\frac{1}{8}'' \times 1\frac{1}{8}''$

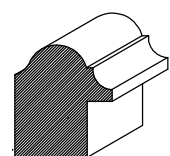

BC-496
 $1\frac{1}{2}'' \times 1\frac{1}{4}''$

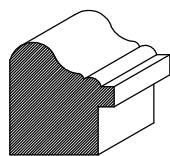

BC-572
 $1\frac{1}{2}'' \times 1\frac{1}{8}''$

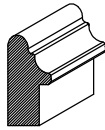

BC-631
 $\frac{11}{16}'' \times 1\frac{1}{2}''$

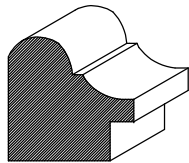

BC-162
 $\frac{1}{2}'' \times \frac{1}{2}''$

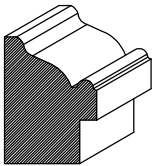

BC-848
 $\frac{1}{16}'' \times 2''$

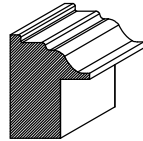

BC-978
 $1\frac{1}{4}'' \times 1\frac{1}{4}''$

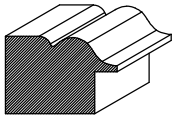

BC-935
 $1\frac{1}{4}'' \times 1\frac{1}{4}''$

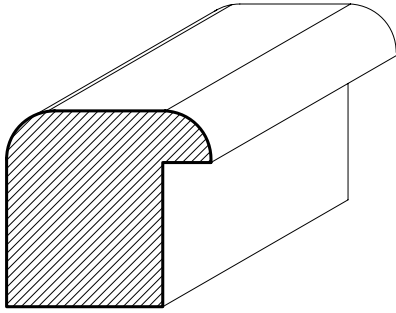

BC-1019
 $1'' \times 1 \frac{1}{16}''$

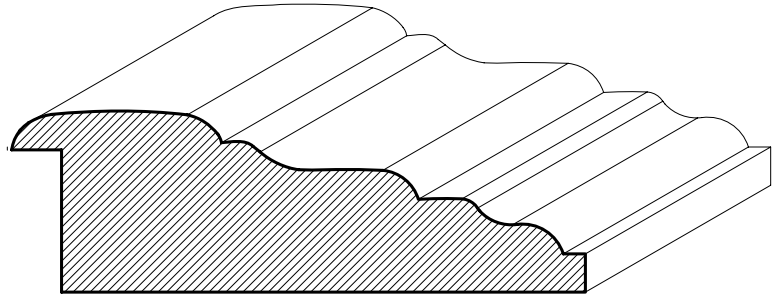

BC-1023
 $\frac{15}{16}'' \times 3''$

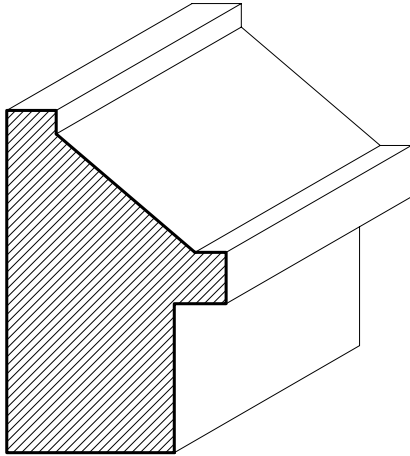

BC-1044
 $1 \frac{3}{4}'' \times 1 \frac{1}{8}''$

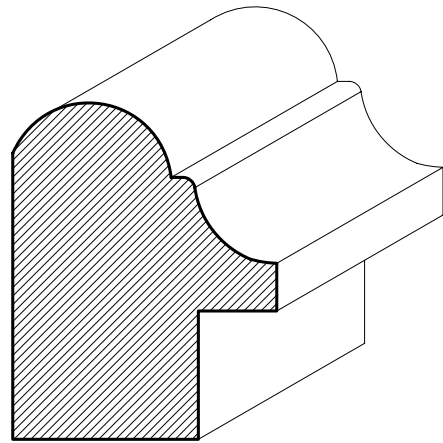

BC-1040
 $1 \frac{3}{4}'' \times 1 \frac{3}{8}''$

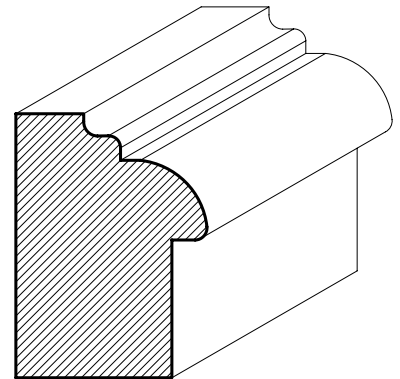

BC-1054
 $1'' \times 1 \frac{3}{8}''$